

ACROVYN® HAND/CRASH RAILS

Elegant and ergonomically designed, Acrovyn combined hand/crash rails provide impact protection in circulation routes, whilst also affording pedestrian support with the rounded top section. There are optional bracket stand-offs and also an anti-ligature option to reduce the risk of ‘suicide by hanging’, as recommended by the National Confidential Enquiry into Suicide. All combined hand/crash rails are available in colours from the Acrovyn range and some can be combined with real wood for a luxurious touch.

HRB20(76), HRB20(93) and HRB20(AL)

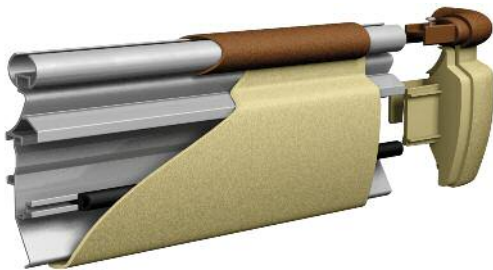

Severe duty combined hand/crash rail for use in circulation routes. Two colours can be used to provide visual contrast.

Dimensions

Fix at max. 800mm centres

Stock lengths 4.0m



Features

- Oval Acrovyn handrail for 335° grip surface combined with crashrail
- Two piece Acrovyn cover which can be supplied in matched or mixed colours for visual contrast
- Shock-absorbing bumper cushion for increased impact protection
- Rapid Fix bracket options for two stand-offs
- HRB20(AL) – anti-ligature option featuring continuous bracket
- Accessories: Acrovyn End Caps and External Corners
- Available in all Acrovyn Profile colours

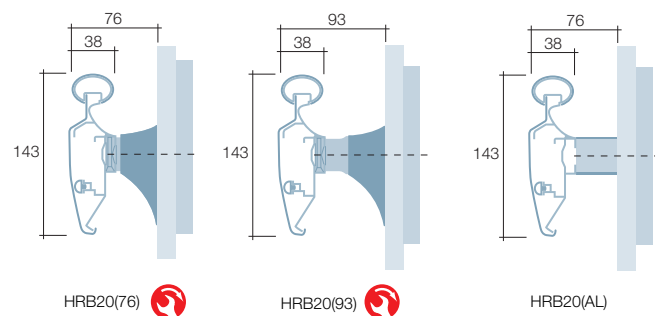

HRBW20(76), HRBW20(93) and HRBW20(AL)

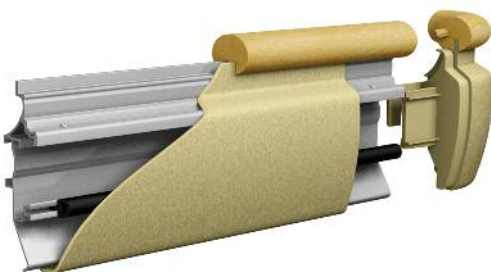

Severe duty timber handrail combined with Acrovyn crashrail for bespoke interior circulation routes

Dimensions

Fix at max. 800mm centres

Stock lengths 4.0m

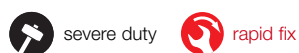

Features

- Oval timber handrail for 335° grip surface combined with Acrovyn crashrail over two-piece aluminium retainer
- Shock-absorbing bumper cushion for increased impact protection
- Rapid Fix bracket options for choice of two stand-offs
- HRB20(AL) – anti-ligature option featuring continuous bracket
- Accessories: mixed timber/Acrovyn End Cap and External Corner
- Timber handrail available in Ash, Oak, Beech and Maple, supplied in natural finish (clear lacquered)
- Acrovyn crashrail available in all Acrovyn Profile colours

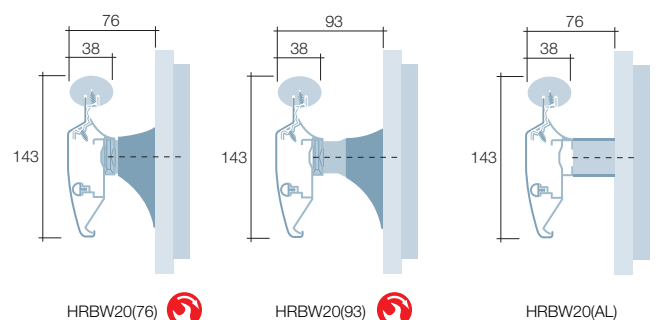



Children's Unit, Llandough Hospital



Heart & Lung Centre, New Cross Hospital, Wolverhampton

HRB35(76) and HRB35(93)



Heavy duty combined hand/crash rail with Rapid Fix brackets for use in corridors



Dimensions

Fix at max. 800mm centres

Stock lengths 4.0m

Features

- Single piece Acrovyn cover over aluminium retainer
- Rapid Fix bracket options with choice of two stand-offs
- Free-floating design allows Acrovyn cover to flex on impact
- Accessories: Acrovyn End Caps and External Corners
- Available in all Acrovyn Profile colours

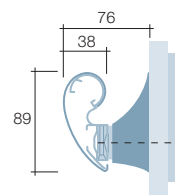

HRB35(76)

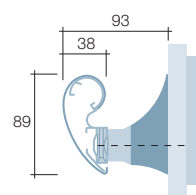

HRB35(93)

HRB4C(76), HRB4C(93) and HRB4C(AL)



Severe duty combined hand/crash rail providing support and impact protection in corridors

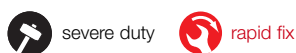

Dimensions

Fix at max. 800mm centres

Stock lengths 4.0m

Features

- Single piece Acrovyn cover over aluminium retainer
- Free-floating design flexes on impact
- Shock-absorbing bumper cushion for increased impact protection
- Rapid Fix brackets in two stand-off options for easy installation
- HRB4C(AL) – anti-ligature option featuring continuous bracket
- Accessories: Acrovyn End Caps, External and Internal Corners
- Available in all Acrovyn Profile colours

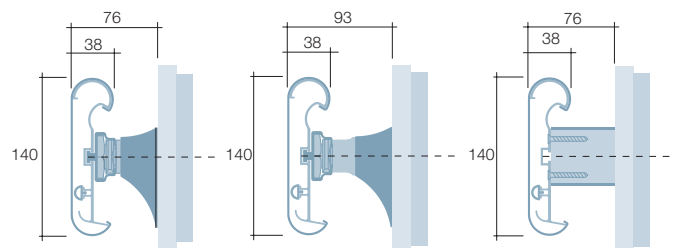

HRB4C(76)

HRB4C(93)

HRB4C(AL)

WALL PROTECTION/HANDRAIL SYSTEMS

CODE COMPLIANT AND BESPOKE

Health Building Note 00-04 offers guidance on the design of handrails combined with wall protection. The principles can be applied to all market sectors, where compliance with Approved Document M is necessary and where wall protection is also required.

Using Acrovyn standard profiles, which are fully compliant with these codes, you can achieve numerous flexible solutions and create unique designs. See below for just a few examples of the many possibilities.

HR6C/ECR50M Combined Hand/Crash rail

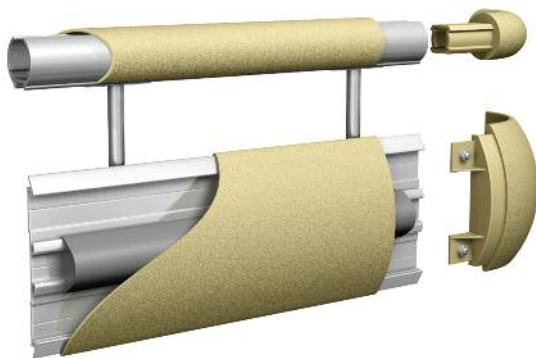

Features

- 40mm Ø handrail with Acrovyn cover over aluminium retainer (or solid timber handrail HRW6C/ECR50M)
- 127mm deep crash rail with curved Acrovyn cover over continuous aluminium retainer and Acrovyn regrind shock absorbing bumper
- Stainless steel mounting bracket with two fixing points for the above
- Accessories:- Acrovyn return to wall End Caps and External Corners. Internal Corners also available for the handrail
- Infill strip for the handrail to close off retainer groove and provide a continuous 'easy clean' surface
- Handrail available in Mission White, Eggshell, French Cream, Wedgewood Blue, Yale Blue, Spectrum Red, Pearl Grey, Charcoal and Imperial Purple
- Crashrail available in all Acrovyn Profile colours

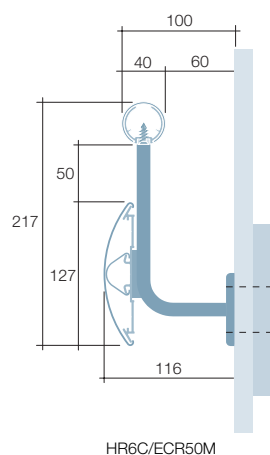

Dimensions

Fix at max. 800mm centres

Stock lengths 4.0m

Approved Document M compliant handrail combined with curved crashrail for durable, impact resistant wall protection on a single bracket.

SEPARATE SOLUTIONS

