

C/S PEDILUXE®

C/S Pediluxe® is the most versatile of all the aluminium profile systems. It combines rugged construction with a luxury 'feel' underfoot and enough tread and colour options to satisfy the most demanding project requirements.

Its exceptional load bearing capability makes it especially suitable for high volume areas such as shopping centres, hospitals and passenger termini. At 17mm deep it fits directly into most existing matwells, facilitating quick and easy installation.

C/S Pediluxe Gold® is the brass rail version offering a simply stunning quality and appearance.



Royal Albert Hall, London

Features

- Recess or surface mounted options
- Rolls up for easy matwell cleaning
- Exceptional rolling load capabilities in excess of 500kgs/wheel (C/S Pediluxe Gold 350kgs/wheel)
- Closed spline option with deep channels allows in situ cleaning along with very high dirt containment
- Open spline option allows dirt to fall into the matwell, the mat can then be rolled up for matwell cleaning
- Field changeable inserts without the use of specialist tools for low lifecycle costs
- C/S Pedijet logo system option for interior grade carpet tread applications (see p25)
- Wide range of tread and colour options (see p22-23)

Example specification (NBS)

N10 General fixtures/Furnishings/Equipment 300 Entrance Matting

Manufacturer: Construction Specialties (UK) Ltd, 1010 Westcott Venture Park, Westcott, Bucks HP18 0XB

Tel: +44 (0)1296 652800 Fax: +44 (0)1296 652888

Product reference: C/S Pediluxe 17mm deep, complete with 20mm frame for recess mounting

Finish: aluminium profiles: mill finish, aluminium frames: mill finish

Tread type: Interior grade carpet insert

Tread colour: Castle Grey 0203

Spline: Closed, Black

Endfiller colour: Black

Matwell size: 2500 mm wide x 4500 mm in traffic direction

Mat size: to suit matwell

C/S Pediluxe® with carpet inserts

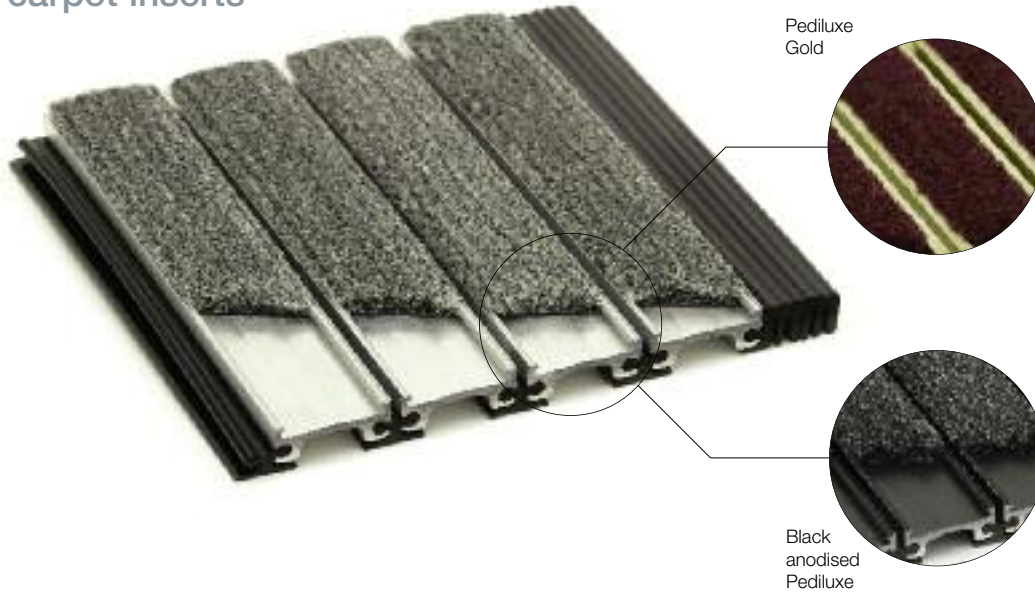

Rail finish options



Mill (standard)

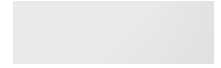

Clear anodised



Black anodised

Sectional detail

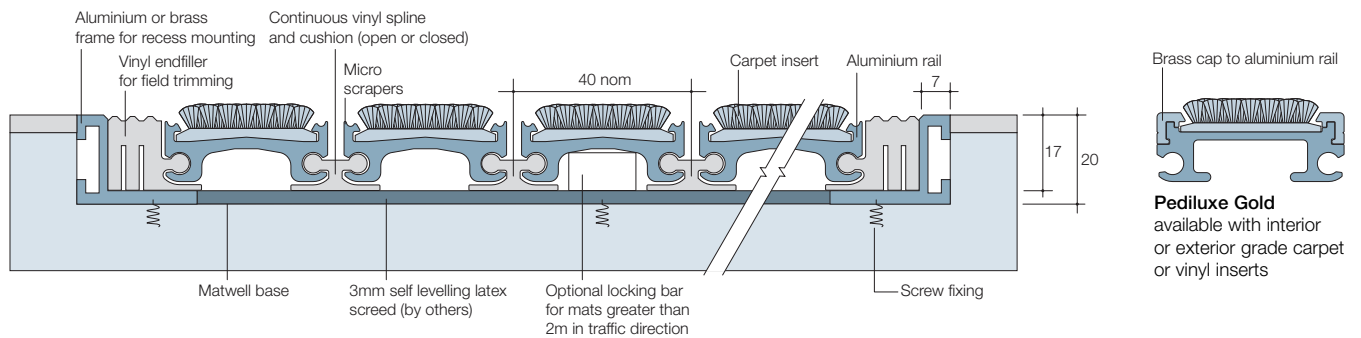

Tread options

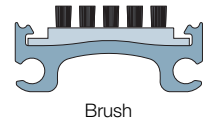
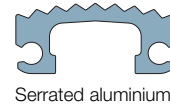
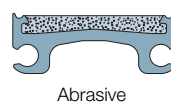
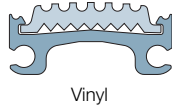
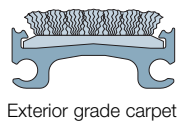
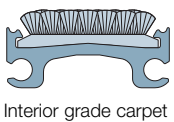

Frame options

20mm Frame for recess mounting

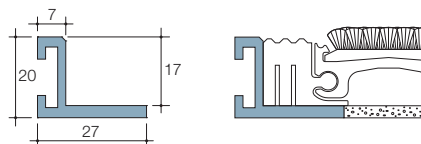

Materials: Aluminium in mill finish or black anodised or brass

21mm T-frame for dividing large sections of mat

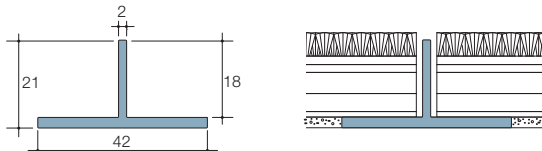

Materials: Aluminium in mill finish or black anodised

17mm Tapered frame for recess mounting

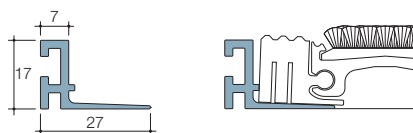

Material: Aluminium in mill finish

17mm Ramped frame for surface mounting

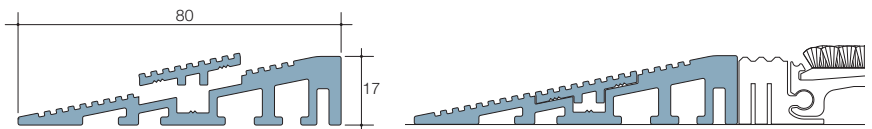

Materials: Aluminium in mill finish, black or clear anodised

Note: Illustrations not to scale