

C/S PEDIMAT®

Pedimat® is the perfect entrance matting solution for buildings in moderate use such as offices, shops, hotels, banks and building societies.

C/S Pedimat can be recessed or surface mounted, either in a ramped frame or to butt level with a surrounding carpet. Carpet, vinyl or abrasive tread inserts can be specified individually or in combination to create a bespoke design.



Lee House, Manchester

Features

- Recess or surface mounted options
- Rolls up for easy matwell cleaning
- Closed spline option allows in situ cleaning along with very high dirt containment
- Open spline option allows dirt to fall into the matwell, the mat can then be rolled up for matwell cleaning
- Field changeable inserts without the use of specialist tools for low lifecycle costs
- C/S Pedijet logo system option for interior grade carpet tread applications (see p25)
- Wide range of tread and colour options (see p22-23)

Example specification (NBS)

N10 General fixtures/Furnishings/Equipment 300 Entrance Matting

Manufacturer: Construction Specialties (UK) Ltd, 1010 Westcott Venture Park, Westcott, Bucks HP18 0XB

Tel: +44 (0)1296 652800 Fax: +44 (0)1296 652888

Product reference: C/S Pedimat 11mm deep, complete with 13mm frame for recess mounting

Finish: aluminium profiles: clear anodised, aluminium frames: mill finish

Tread type: Interior grade carpet insert

Tread colour: Sandstone 0205

Spline: Closed, Black

Endfiller colour: Black

Matwell size: 5000 mm x 4500 mm in traffic direction

Mat size: to suit matwell

C/S Pedimat® with carpet inserts



Rail finish options

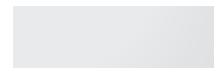

Clear anodised (standard)



Black anodised



Bronze anodised



Gold anodised

Sectional detail

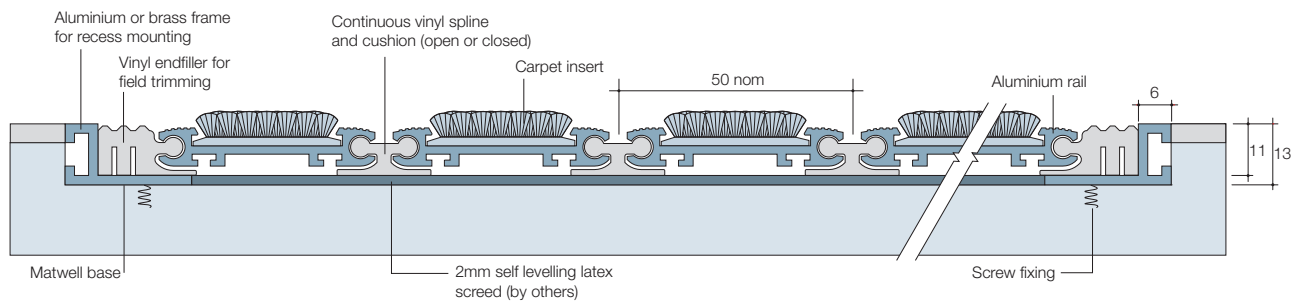

Tread options

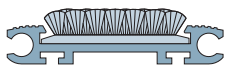

Interior grade carpet

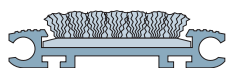

Exterior grade carpet

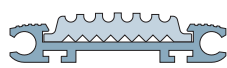

Vinyl

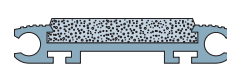

Abrasive



Brush

Frame options

13mm Frame for recess mounting

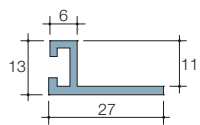

Materials:
Aluminium in mill finish, black, bronze or gold anodised, or brass

Carpet edge grip for abutting carpet flooring

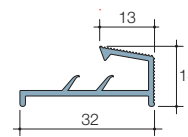

Materials:
Aluminium in mill finish, black, bronze or gold anodised

13mm T-frame for dividing large sections of mat

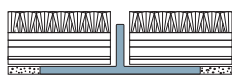
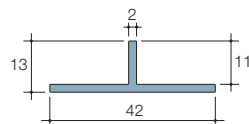

Materials:
Aluminium in mill finish, black, bronze or gold anodised

Carpet edge trim for abutting carpet flooring

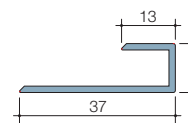

Materials:
Aluminium in mill finish, black, bronze or gold anodised

11mm Ramped frame for surface mounting

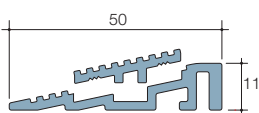

Materials:
Aluminium in mill finish, black, bronze, gold or clear anodised

Note: Illustrations not to scale