

# C/S PEDIMAT® ULTRA

Pedimat® Ultra is elegant, slimline and economical, whilst also providing an increased absorption area and strength when compared with standard Pedimat. With its 11mm slim depth profile, as well as fitting in a standard matwell, it can also easily fit alongside floor tiles and carpets to produce a flush floor finish.

It is suitable for medium to high use areas such as busy offices, surgeries and schools.



CrownGate Shopping Centre, Worcester

## Features

- Recess or surface mounted options
- Rolls up for easy matwell cleaning
- 275kgs/wheel rolling load capability
- Closed spline option with deep channels allows in situ cleaning along with very high dirt containment
- Field changeable inserts without the use of specialist tools for low lifecycle costs
- C/S Pedijet logo system option for interior grade carpet tread applications (see p25)
- Wide range of tread and colour options (see p22-23)

## Example specification (NBS)

N10 General fixtures/Furnishings/Equipment 300 Entrance Matting

*Manufacturer:* Construction Specialties (UK) Ltd, 1010 Westcott Venture Park, Westcott, Bucks HP18 0XB

Tel: +44 (0)1296 652800 Fax: +44 (0)1296 652888

*Product reference:* C/S Pedimat Ultra 11mm deep, complete with 13mm frame for recess mounting

*Finish:* aluminium profiles: mill finish, aluminium frames: mill finish

*Tread type:* Interior grade carpet insert

*Tread colour:* Wrought Iron 0202

*Endfiller and spline colour:* Black

*Matwell size:* 4000 mm wide x 5600 mm in traffic direction

*Mat size:* to suit matwell

## C/S Pedimat® Ultra with carpet inserts



## Rail finish options



Mill (standard)

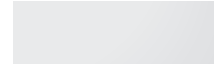

Clear anodised



Black anodised

## Sectional detail

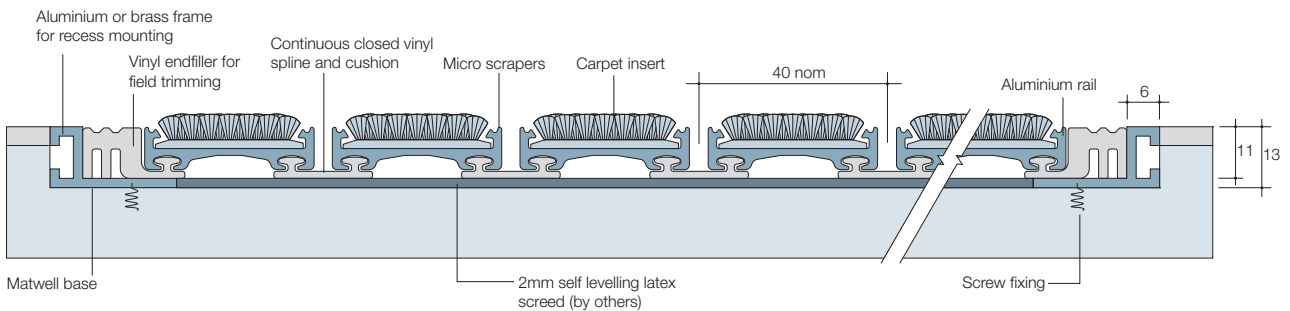

## Tread options

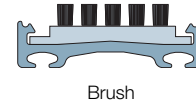
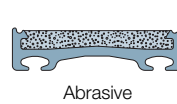
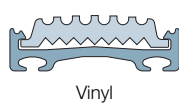
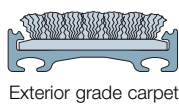
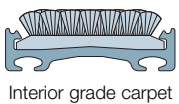

## Frame options

### 13mm Frame for recess mounting

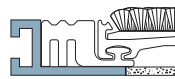
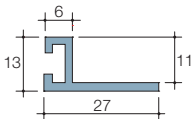

Materials:  
Aluminium in mill finish,  
black, bronze or gold  
anodised, or brass

### Carpet edge grip for abutting carpet flooring

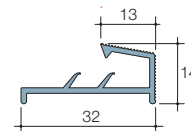

Materials:  
Aluminium in mill finish,  
black, bronze or gold  
anodised

### 13mm T-frame for dividing large sections of mat

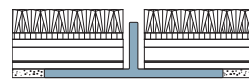
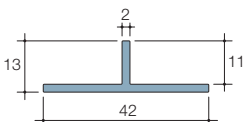

Materials:  
Aluminium in mill finish,  
black, bronze or gold  
anodised

### Carpet edge trim for abutting carpet flooring

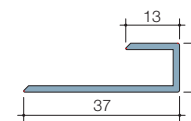

Materials:  
Aluminium in mill finish,  
black, bronze or gold  
anodised

### 11mm Ramped frame for surface mounting

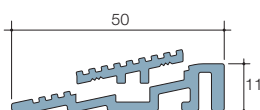

Materials:  
Aluminium in mill finish,  
black, bronze, gold or  
clear anodised

Note: Illustrations not to scale